

Article number: 2302069897
Description: E+G Lobe knob
VCT.40 FP-M6

Measures

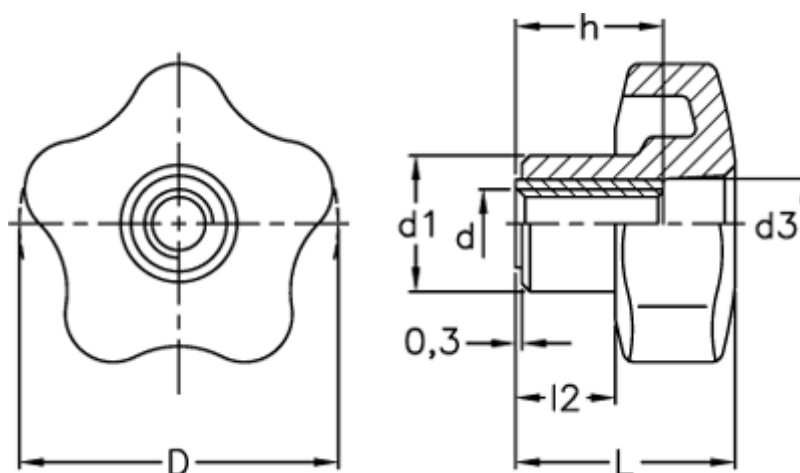

D	= 40
d1	= 17
d3	= 12
d 6H	= M6
h	= 18
L	= 27.0
l2	= 12